

Bidirectional Switch with NPT³ IGBT and fast Diode Bridge in ISOPLUS i4-PAC™

$I_{C25} = 50 \text{ A}$
 $V_{CES} = 1200 \text{ V}$
 $V_{CE(sat) \text{ typ.}} = 2.0 \text{ V}$

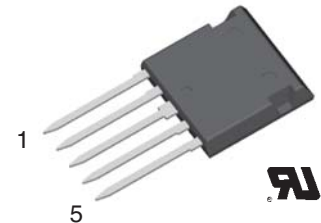
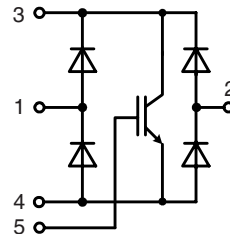

IGBT

Symbol	Conditions	Maximum Ratings	
V_{CES}	$T_{VJ} = 25^{\circ}\text{C to } 150^{\circ}\text{C}$	1200	V
V_{GES}		± 20	V
I_{C25}	$T_C = 25^{\circ}\text{C}$	50	A
I_{C90}	$T_C = 90^{\circ}\text{C}$	32	A
I_{CM} V_{CEK}	$V_{GE} = \pm 15 \text{ V}; R_G = 39 \Omega; T_{VJ} = 125^{\circ}\text{C}$ RBSOA, Clamped inductive load; $L = 100 \mu\text{H}$	50	A
		V_{CES}	
t_{SC} (SCSOA)	$V_{CE} = 900\text{V}; V_{GE} = \pm 15 \text{ V}; R_G = 39 \Omega; T_{VJ} = 125^{\circ}\text{C}$ non-repetitive	10	μs
P_{tot}	$T_C = 25^{\circ}\text{C}$	200	W

Features

- NPT³ IGBT
 - low saturation voltage
 - positive temperature coefficient for easy paralleling
 - fast switching
 - short tail current for optimized performance in resonant circuits
- HiPerFRED™ diodes
 - fast reverse recovery
 - low operating forward voltage
 - low leakage current
- ISOPLUS i4-PAC™ package
 - isolated back surface
 - low coupling capacity between pins and heatsink
 - enlarged creepage towards heatsink
 - application friendly pinout
 - low inductive current path
 - high reliability
 - industry standard outline
 - UL registered, E 72873

Symbol	Conditions	Characteristic Values ($T_{VJ} = 25^{\circ}\text{C}$, unless otherwise specified)		
		min.	typ.	max.
$V_{CE(sat)}$	$I_C = 30 \text{ A}; V_{GE} = 15 \text{ V}; T_{VJ} = 25^{\circ}\text{C}$ $T_{VJ} = 125^{\circ}\text{C}$	2.0 2.3	2.6	V V
$V_{GE(th)}$	$I_C = 1 \text{ mA}; V_{GE} = V_{CE}$	4.5	6.5	V
I_{CES}	$V_{CE} = V_{CES}; V_{GE} = 0 \text{ V}; T_{VJ} = 25^{\circ}\text{C}$ $T_{VJ} = 125^{\circ}\text{C}$	0.4	0.4	mA mA
I_{GES}	$V_{CE} = 0 \text{ V}; V_{GE} = \pm 20 \text{ V}$		200	nA
$t_{d(on)}$ t_r $t_{d(off)}$ t_f E_{on} E_{off}	Inductive load, $T_{VJ} = 125^{\circ}\text{C}$ $V_{CE} = 600 \text{ V}; I_C = 30 \text{ A}$ $V_{GE} = \pm 15 \text{ V}; R_G = 39 \Omega$	85		ns
		50		ns
		440		ns
		50		ns
		4.6		mJ
		2.2		mJ
C_{ies}	$V_{CE} = 25 \text{ V}; V_{GE} = 0 \text{ V}; f = 1 \text{ MHz}$	2		nF
Q_{Gon}	$V_{CE} = 600 \text{ V}; V_{GE} = 15 \text{ V}; I_C = 35 \text{ A}$	150		nC
R_{thJC} R_{thJS}		1.2	0.6	KW KW

Applications

switches to control bidirectional current flow by a single control signal:

- matrix converters
- spare matrix converters
- AC controllers

Diodes

Symbol	Conditions	Maximum Ratings	
I_{F25}	$T_C = 25^\circ\text{C}$	48	A
I_{F90}	$T_C = 90^\circ\text{C}$	25	A

Symbol	Conditions	Characteristic Values		
		min.	typ.	max.
V_F	$I_F = 30\text{ A}; T_{VJ} = 25^\circ\text{C}$ $T_{VJ} = 125^\circ\text{C}$	2.4	2.8	V
		1.8		V
I_{RM} t_{rr}		27		A
		150		ns
R_{thJC} R_{thJS}	(per diode)	1.6		1.3 K/W K/W

Component

Symbol	Conditions	Maximum Ratings	
T_{VJ}		-55...+150	$^\circ\text{C}$
T_{stg}		-55...+125	$^\circ\text{C}$
V_{ISOL}	$I_{ISOL} \leq 1\text{ mA}; 50/60\text{ Hz}$	2500	V~
F_C	mounting force with clip	20...120	N

Symbol	Conditions	Characteristic Values		
		min.	typ.	max.
C_p	coupling capacity between shorted pins and mounting tab in the case		40	pF
d_{S,d_A}	pin - pin	1.7		mm
d_{S,d_A}	pin - backside metal	5.5		mm
Weight		9		g

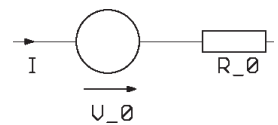
Equivalent Circuits for Simulation
Conduction

IGBT (typ. at $V_{GE} = 15\text{ V}; T_J = 125^\circ\text{C}$)
 $V_0 = 0.95\text{ V}; R_0 = 45\text{ m}\Omega$

Diode (typ. at $T_J = 125^\circ\text{C}$)
 $V_0 = 1.26\text{ V}; R_0 = 15\text{ m}\Omega$

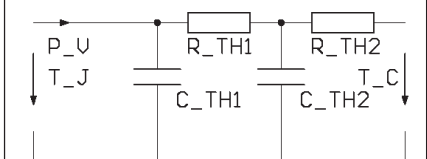
Thermal Response

IGBT

$C_{th1} = 0.067\text{ J/K}; R_{th1} = 0.108\text{ K/W}$
 $C_{th2} = 0.175\text{ J/K}; R_{th2} = 0.491\text{ K/W}$

Diode

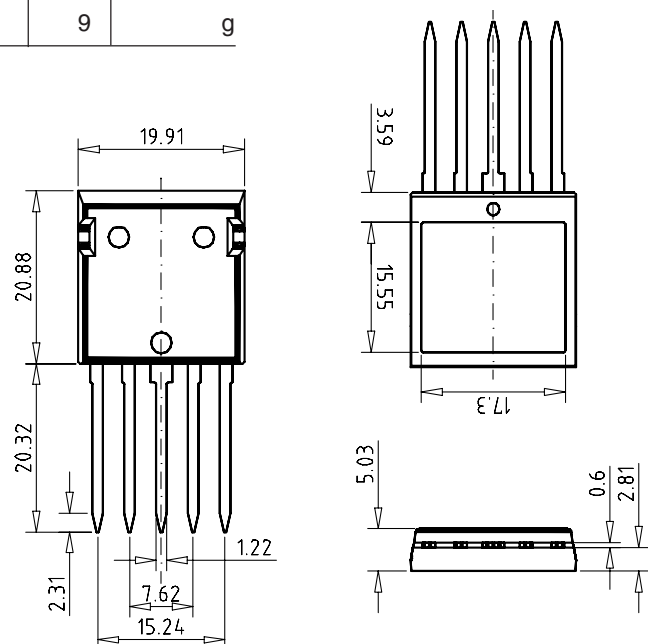
$C_{th1} = 0.039\text{ J/K}; R_{th1} = 0.337\text{ K/W}$
 $C_{th2} = 0.090\text{ J/K}; R_{th2} = 0.963\text{ K/W}$

Dimensions in mm (1 mm = 0.0394")

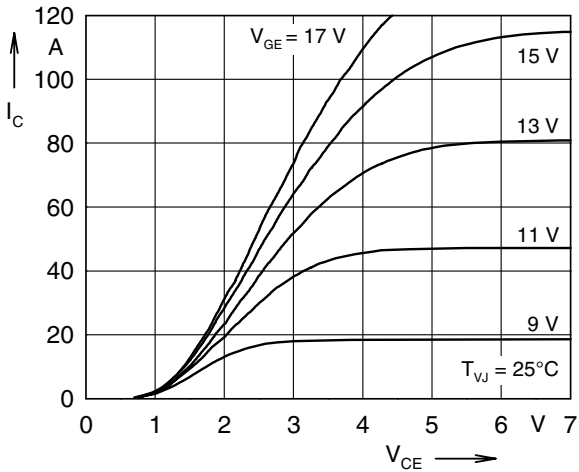

Fig. 1 Typ. output characteristics

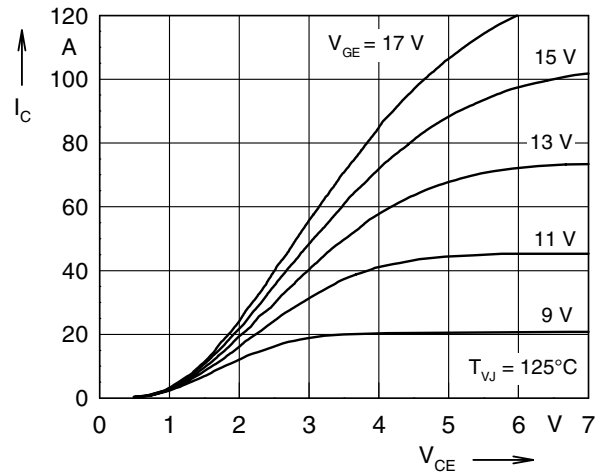

Fig. 2 Typ. output characteristics

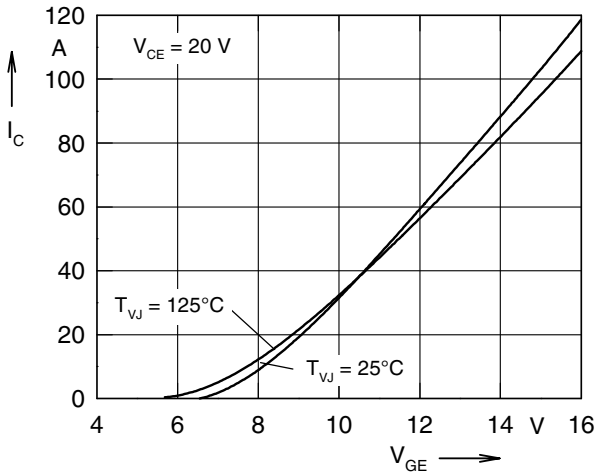

Fig. 3 Typ. transfer characteristics

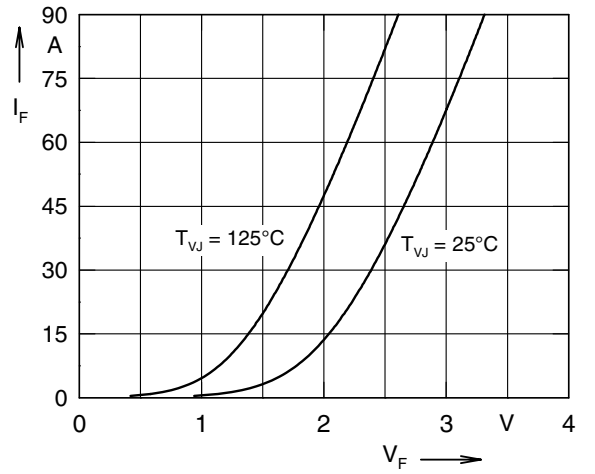

Fig. 4 Typ. forward characteristics of free wheeling diode

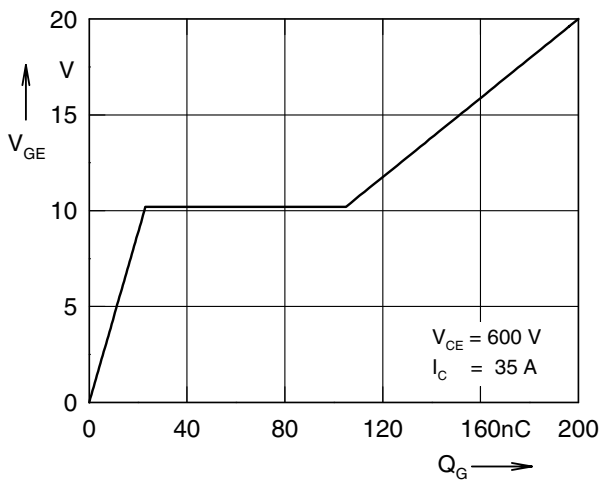

Fig. 5 Typ. turn on gate charge

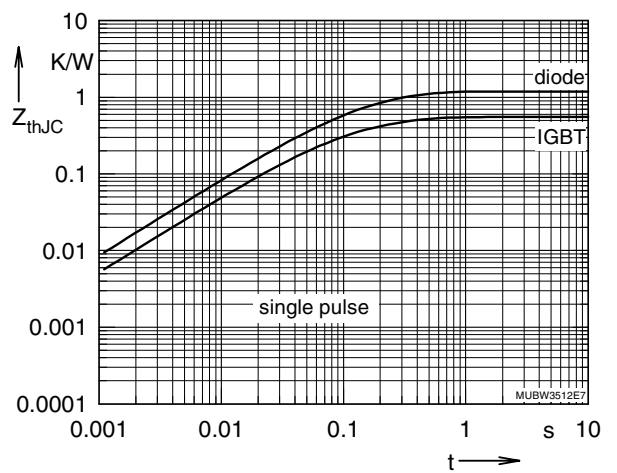

Fig. 6 Typ. transient thermal impedance

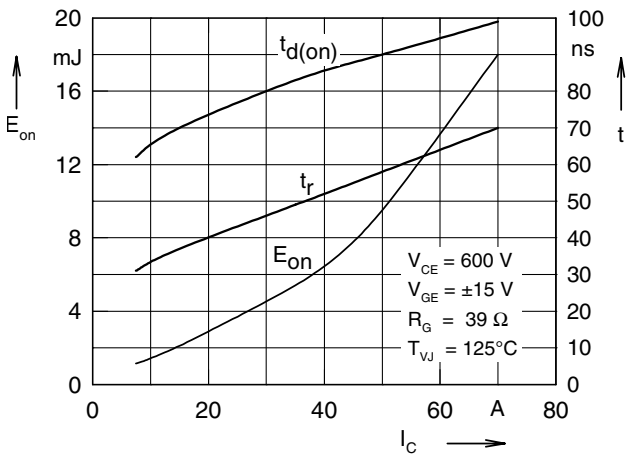

Fig. 7 Typ. turn on energy and switching times versus collector current

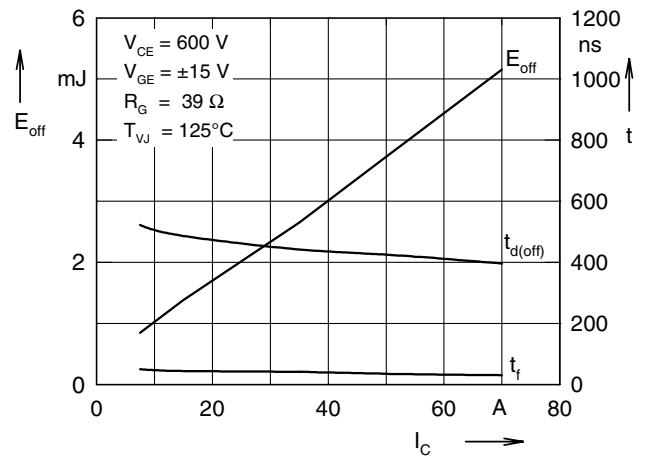

Fig. 8 Typ. turn off energy and switching times versus collector current

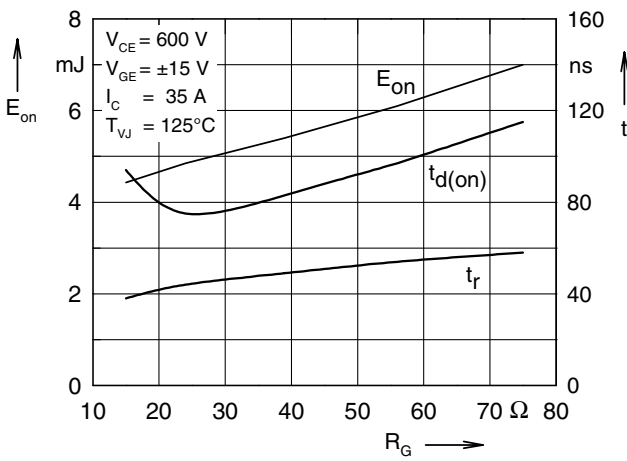

Fig. 9 Typ. turn on energy and switching times versus gate resistor

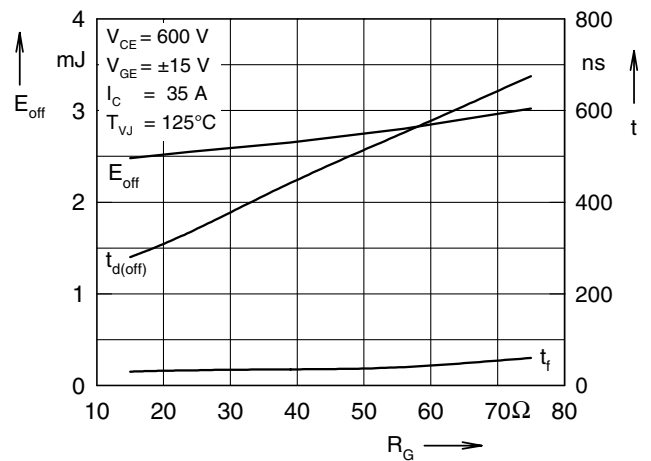

Fig.10 Typ. turn off energy and switching times versus gate resistor